

- | | | |
|-------|---|-------------------------|
| (E) | Instrucción de montaje ¡Leer primero! | Kit fijación |
| (GB) | Assembly instructions Read first! | Fixation Kit |
| (F) | Instruction de montage Lire en premier! | Kit fixation |
| (D) | Montageanleitung Zuerst lesen! | Stützfuß-Kit |
| (PT) | Instruções de montagem Ler primeiro! | Kit fixação |
| (PL) | Instrukcja montażu Najpierw przeczytaj! | Element mocujący |
| (CZ) | Montážní návod Čtěte pozorně! | Fixační kit |
| (HU) | Szerelési Utasítás Először olvassd el! | Rögzítő készlet |
| (RO) | Instructiuni de montaj Intai cititi! | Kit de fixare |
| (HR) | Detaljne upute Prvo pročitati! | Kit za montažu |
| (GR) | Διαβάστε προσεκτικά τις Οδηγίες Συναρμολόγησης! | Κιβώτιο (Kit) Επισκευής |
| (TR) | Öncelikle montaj: Talimatlarını okuyunuz! | Montaj kiti |
| (RU) | Инструкции по монтажу Сначала прочитайте! | Крепежный комплект |
| (I) | Istruzioni di montaggio Leggere per primo! | Kit di fissaggio |
| (NL) | Montagehandleiding Eerst lezen! | Bevestigingsset |
| (SLO) | Navodila za sestavljanje Preberite! | Kit za pričvrstitev |

935-643

Lv7 2022-r5

Modelo-model:

Optiplus

Lote-Lot-Lot-Lot:

02-22

Peso-Weight-Poids-Gewicht:

0,90 kg



Kit tipo (Certificación)
Kit type (Certification)
Kit type (Certificat)
Kit Typ (Zertifizierung)

A

CEE - EEC type approval:

(E₉) 26 R- 04 3015

CRUZBER SA
ES-A14018311
P.I. Las Salinas II
14960 - Rute - Spain
www.cruzber.com



1.



x1



x1



(018-041)

x1



(810-045)

x4

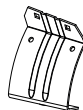

1x (1177)
1x (1178)
1x (1179)
1x (1180)

x4



2x (012-060)
2x (012-100)

x1



(001-820)

x4

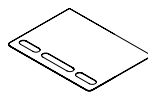

(018-098)



Importante!
Important!
Important!
Wichtig!

(E) ¡Este Kit de fijación tiene que usarse con sistemas porta-cargas Cruz!

(GB) This fixation Kit must be used with Cruz roof rack systems!

(F) Cet Kit de fixation devra être utilisé avec les systèmes porte-charge Cruz!

(D) Dieser Stützfuß-Kit muß mit Cruz Dachträgersystemen benutzt werden!

(PT) Este Kit de fixação deve ser utilizado com os sistemas porta cargas Cruz!

(PL) Niniejszy element mocujący musi być używany z systemami bagażników dachowych firmy Cruz!

(CZ) Tento fixační kit musí být používán s nosným systémem Cruz!

(HU) Ez a rögzítő készlet csak a Cruz rendszerekkel használható!

(RO) Acest Kit de fixare, trebuie utilizat cu sisteme Cruz!

(HR) Kit za montažu mora biti korišten uz Cruz sistem krovnog nosača!

(GR) Το αξεσουάρ αυτό θα πρέπει να χρησιμοποιείται αποκλειστικά στα συστήματα μπαρών της Cruz!

(TR) Bu aksesuar mutlaka Cruz taşıma sistemleriyle kullanılmalıdır!

(RU) Крепежный комплект должен быть использован с багажной системой на крышу марки Cruz!

(IT) Questo kit di fissaggio deve essere usato con i portapacchi Cruz

(NL) Deze bevestigingsset moet worden gebruikt in combinatie met Cruz dakdrager systeem!

(SLO) Kit za pričvrstitev naj se uporablja le z izdelki iz asortimana strešnih košar Cruz!

2. 

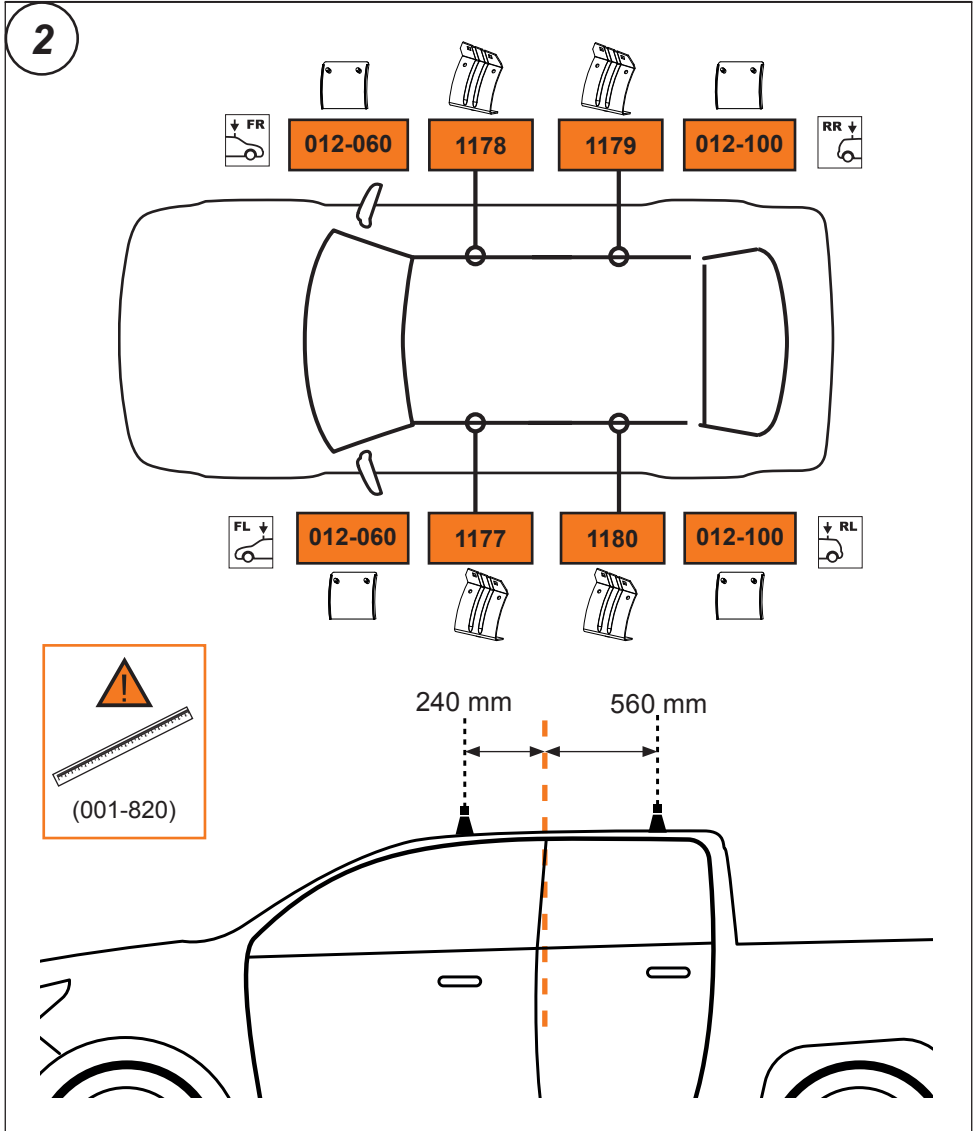

3. 

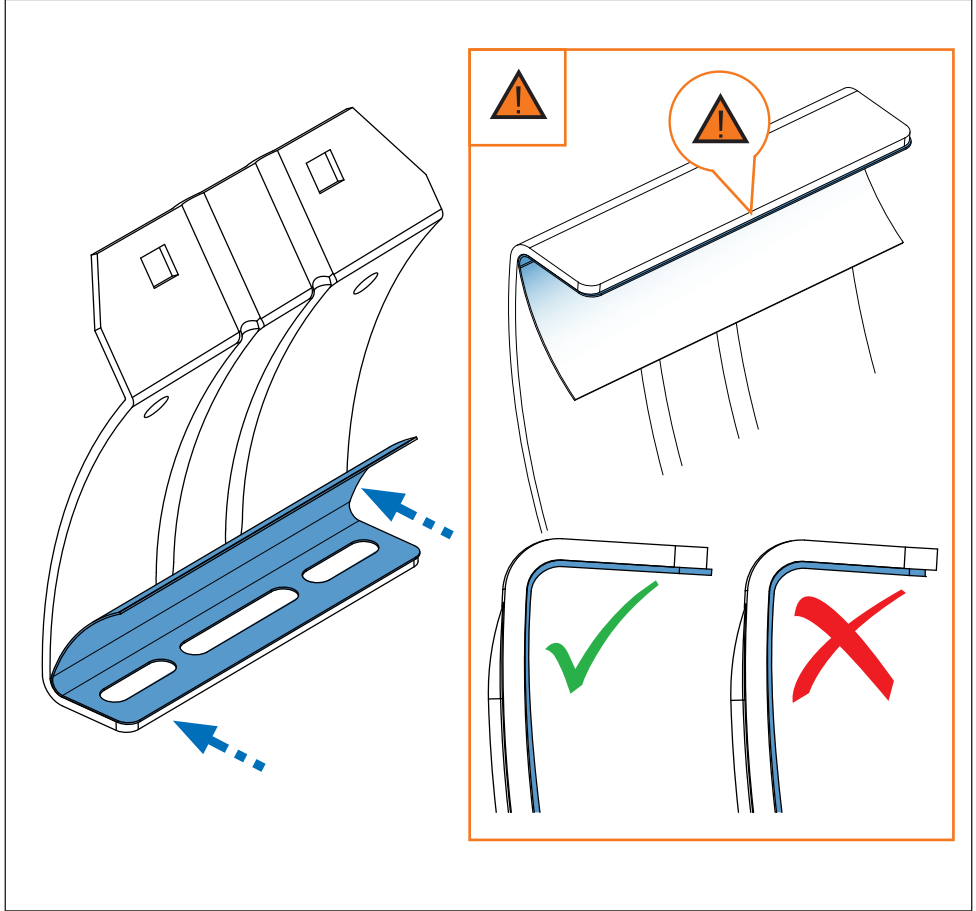
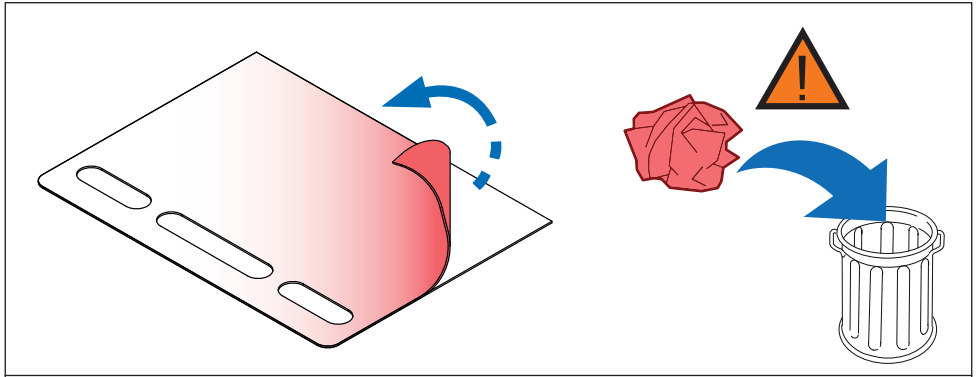

4. 

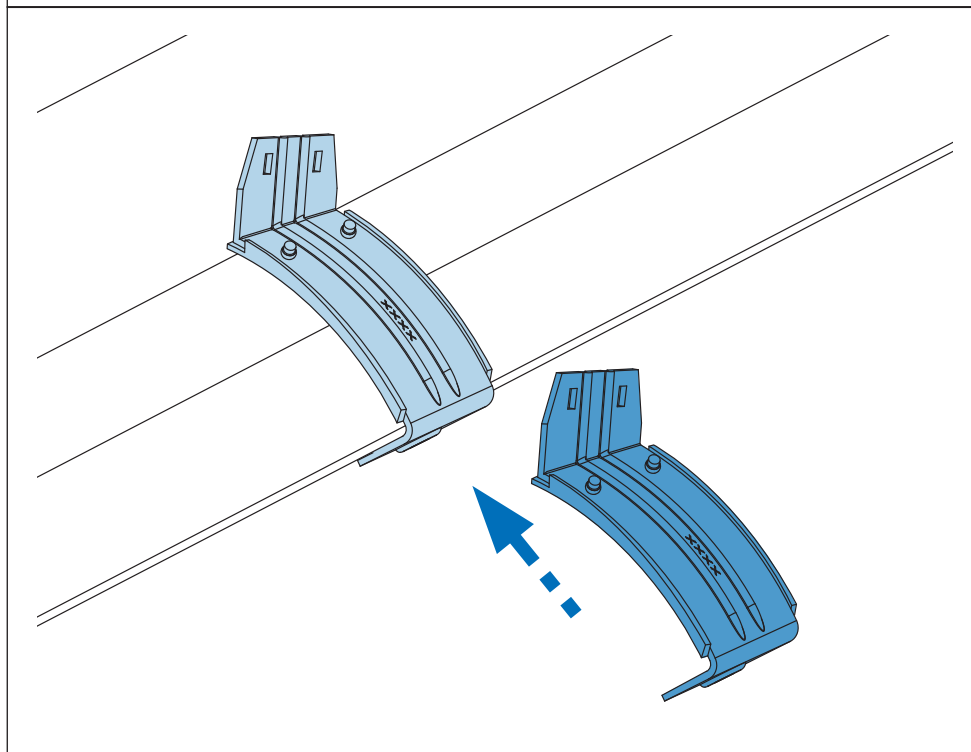
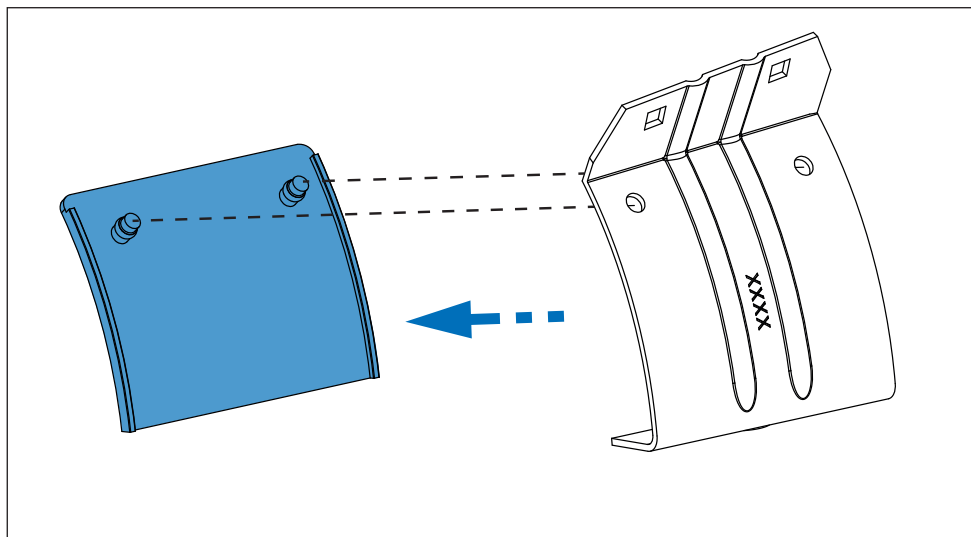

5. 

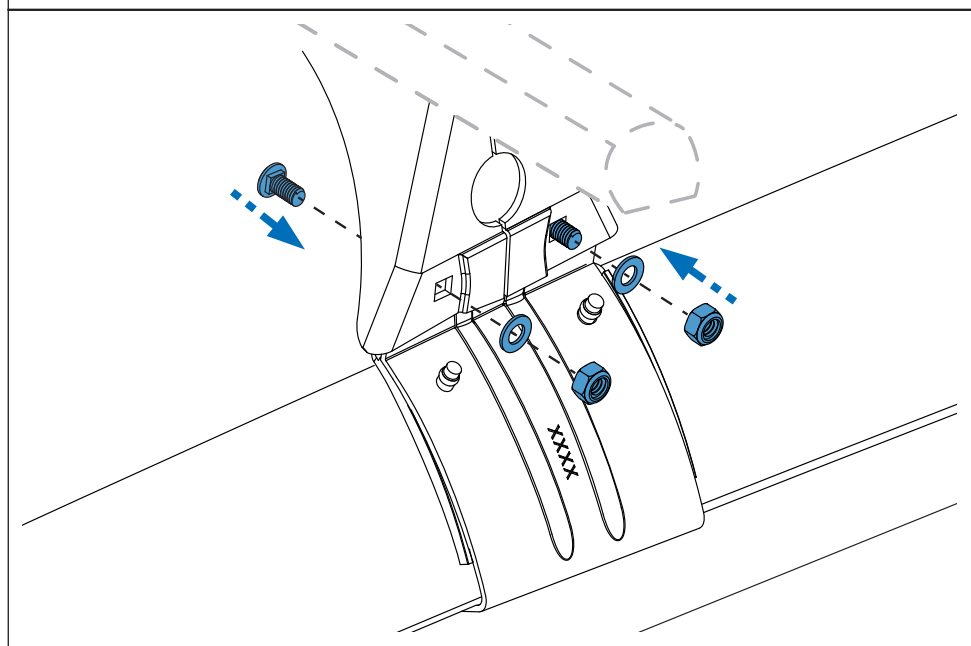
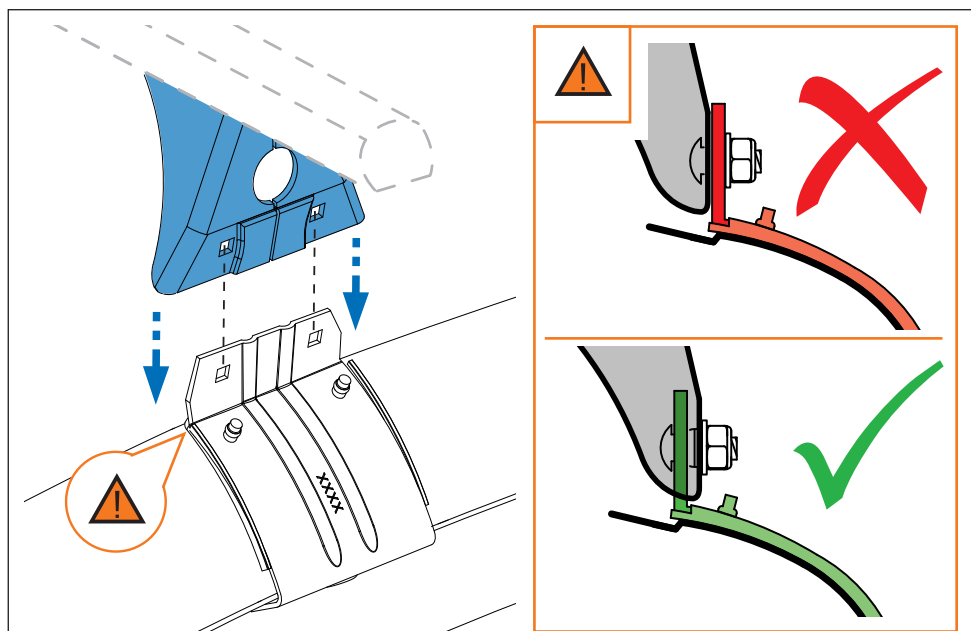

6. 

