



- (E) **Instrucción de montaje**  
¡Leer primero!
- (GB) **Assembly instructions**  
Read first!
- (F) **Instruction de montage**  
Lire en premier!
- (D) **Montageanleitung**  
Zuerst lesen!
- (PT) **Instruções de montagem**  
Ler primeiro!
- (PL) **Instrukcja montażu**  
Najpierw przeczytaj!
- (CZ) **Montážní návod**  
Čtěte pozorně!
- (HU) **Szerelési Utasítás**  
Először olvasd el!
- (RO) **Instructiuni de montaj**  
Intai cititi!
- (HR) **Detaljne upute**  
Prvo procitati!
- (GR) **Διαβάστε προσεκτικά τις**  
Οδηγίες Συναρμολόγησης!
- (TR) **Öncelikle montaj:**  
Talimatlarını okuyunuz!
- (RU) **Инструкции по монтажу**  
Сначала прочитайте!
- (I) **Istruzioni di montaggio**  
Leggere per primo!
- (NL) **Montagehandleiding**  
Eerst lezen!
- (SLO) **Navodila za sestavljanje**  
Preberite!
- Barras de aluminio
- Aluminium bars
- Barres d'aluminium
- Aluminiumdachträger
- Barras d'alumínio
- Belki aluminiowe
- Hliníková sada tyčí
- Aluminium rudak
- Aluminijske šipke
- Bare din aluminiu
- Μπάρες Αλουμινίου
- Alüminyum barlar
- Алюминиевые поперечины
- Barre di alluminio
- Aluminium dakdragers
- Aluminijske prečke

# 924-08x

Lv7 2018-r9

Modelo-model:

## Alu Cargo AF

Lote-Lot-Lot-Lot:



Peso-Weight-Poids-Gewicht:

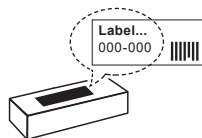

**Max. 50 kg**

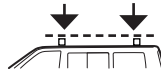

CEE - EEC type approval:



26 R- 04 3022



**CITY CRASH** (M)

CRUZBER SA  
ES-A14018311  
P.I. Las Salinas II  
14960 - Rute - Spain  
[www.cruzber.com](http://www.cruzber.com)



1.

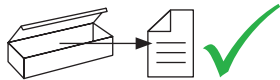

(E) Contenido embalaje: ¡Verificar!

x1

x1

(GB) Package content: Check!



(F) Contenu d'emballage: Vérifier!

(D) Packungsinhalt: Überprüfen!

x1

(PT) Conteúdo embalagem:  
Verificar!

(PL) Zawartość opakowania:  
sprawdź!

(CZ) Obsah balení: Zkontrolujte!

(HU) Csomag tartalma: Ellenőrizd!

(RO) Pachetul contine: Verificati!

(HR) Sadržaj paketa: Provjeri!

(GR) Ελέγξτε το περιεχόμενο του  
πακέτου!

(TR) Paket içeriğini: Control ediniz!



(RU) Содержание упаковки:  
Проверьте!

(I) Contenuto della confezione:  
Controllare!

(NL) Pakket inhoud: Controleer!

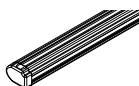
(SLO) Vsebina paketa: Preverite!



Código Code		$\longleftrightarrow$			Lote Lot
924-070	AF 118 (824-062)	118 cm	1x (012-151) 1x (012-152)	1,85 kg	01/18
924-085	AF 128 (824-064)	128 cm		2,00 kg	02/15
924-086	AF 138 (824-069)	138 cm		2,12 kg	02/15
924-087	AF 148 (824-074)	148 cm		2,30 kg	02/15
924-088	AF 158 (824-079)	158 cm		2,40 kg	02/15
924-089	AF 175 (824-084)	175 cm		2,50 kg	02/15

## 2.



**Importante!**  
**Important!**  
**Important!**  
**Wichtig!**

- (E)** Estas barras tienen que usarse con Kits de fijación Cruz!
- (GB)** Bars must be used with Cruz fixation Kits!
- (F)** Les barres devront être utilisées avec les Kits de fixation Cruz!
- (D)** Die Dachlsträger nur mit Cruz Stützfuß-Kits befestigen!
- (PT)** As barras devem ser utilizadas com os Kits de fixação Cruz!
- (PL)** Belki muszą być stosowane z elementów mocującymi firmy Cruz!
- (CZ)** Tento nosič musí být používán s fixačním kitem Cruz!
- (HU)** A rudakat csak Cruz rögzítő készlettel szabad használni!
- (RO)** Barele trebuie utilizate cu Kit-uri de fixare Cruz!
- (HR)** Šipke moraju biti korištene sa Cruz kitovima za montažu!
- (GR)** Το αξεσουάρ αυτό θα πρέπει να χρησιμοποιείται αποκλειστικά στα συστήματα μπαρών της Cruz!
- (TR)** Bu barlar mutlak Cruz montaj kiti!
- (RU)** Поперечины должны быть использованы со специальным крепежным комплектом Cruz!
- (IT)** Questa bare deve essere utilizzato solo con il kit di fissaggio Cruz!
- (NL)** Dakdragers moeten worden gebruikt in combinatie met de bevestigingssets van Cruz!

1

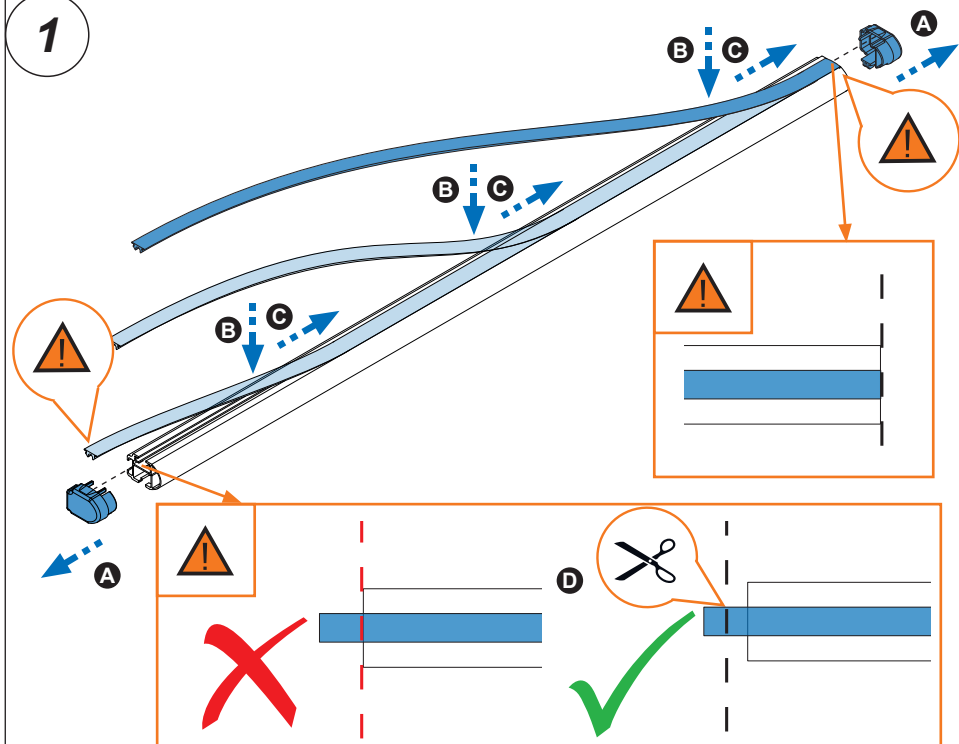

3. 

**2**

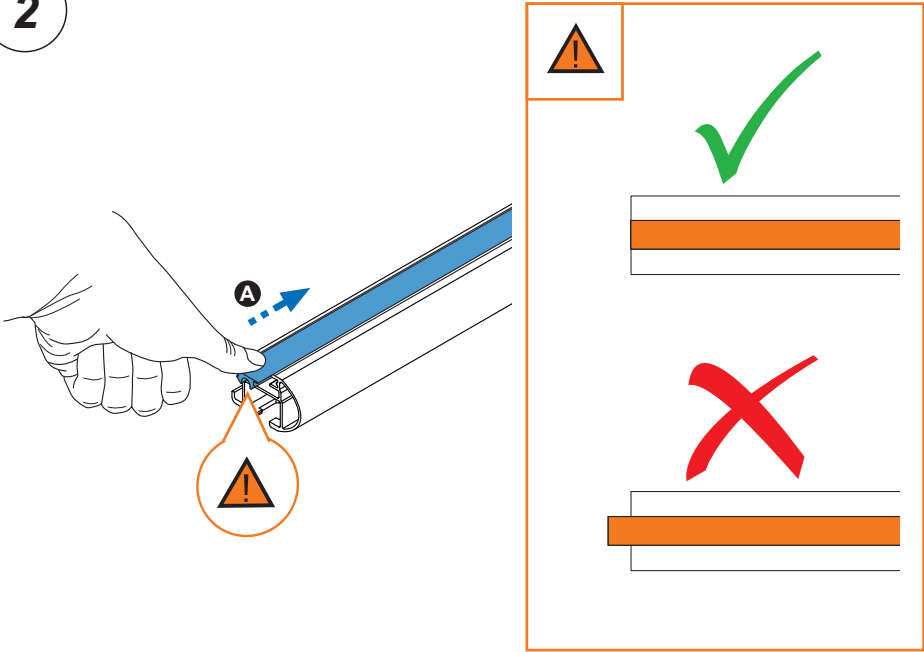

The diagram illustrates the correct and incorrect ways to handle the extrusion profile. A hand is shown holding the profile, with a blue arrow 'A' pointing to the top edge. A red circle with an exclamation mark icon is drawn around the bottom edge, indicating a warning. To the right, a box contains a warning icon, a green checkmark above a white bar with an orange stripe, and a red 'X' above another white bar with an orange stripe.

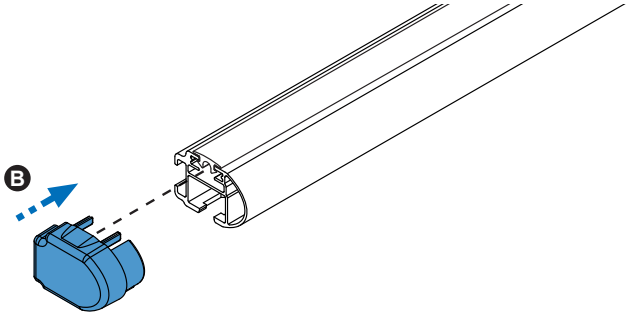

The diagram shows a blue extrusion profile being inserted into a blue component. A blue arrow labeled 'B' points to the component.

**3**

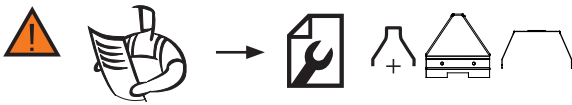

The icon sequence consists of a warning icon, a hand holding a document, an arrow, a wrench icon, a plus sign, and three different extrusion profiles.